

## Design Studio • **Rapidly Deployable Shelter** • WS2022 • USTUTT

Teaching Assistant: Moon Young Jeong (ILEK)  
Supervisor: Jun. Prof. Dr.-Ing. Maria Matheou (ILEK)

ADDitively Manufactured OPTimized Structures by means of Machine Learning  
Institute for Lightweight Structures and Conceptual Design (ILEK) | University of Stuttgart

**ILEK**



### Acknowledgments

This research was supported by the ADDOPTML project:  
“ADDitively Manufactured OPTi-mized Structures by means of Machine Learning” (No: 101007595)  
belonging to the Marie Skłodowska-Curie Actions (MSCA) Research and  
Innovation Staff Exchange (RISE) H2020-MSCA-RISE-2020.



# Bahay Cono

Rapidly Deployable Shelter  
WS22/23

Eman Pagala  
Weifeng He  
Keiya Nakazato

# Contents

- 1. Site Analysis**
- 2. Concept**
- 3. Phase 1**
- 4. Phase 2**
- 5. Rendering**

## Site analysis

# Location



Type	Dry Season	Wet Season
I	November - April	Rest of the year
II	No dry season	Maximum rain period from December to February; Minimum rainfall during the period from March to May
III	Short dry season either during the period from December to February or from March to May	No very pronounced maximum rain period
IV	No dry season	Rainfall evenly distributed throughout the year

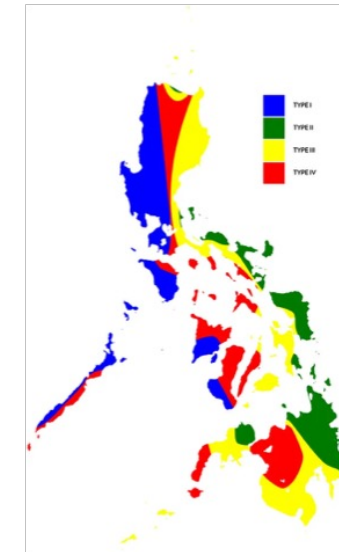

<https://www.discoverthephilippines.com/climate-of-the-philippines/>

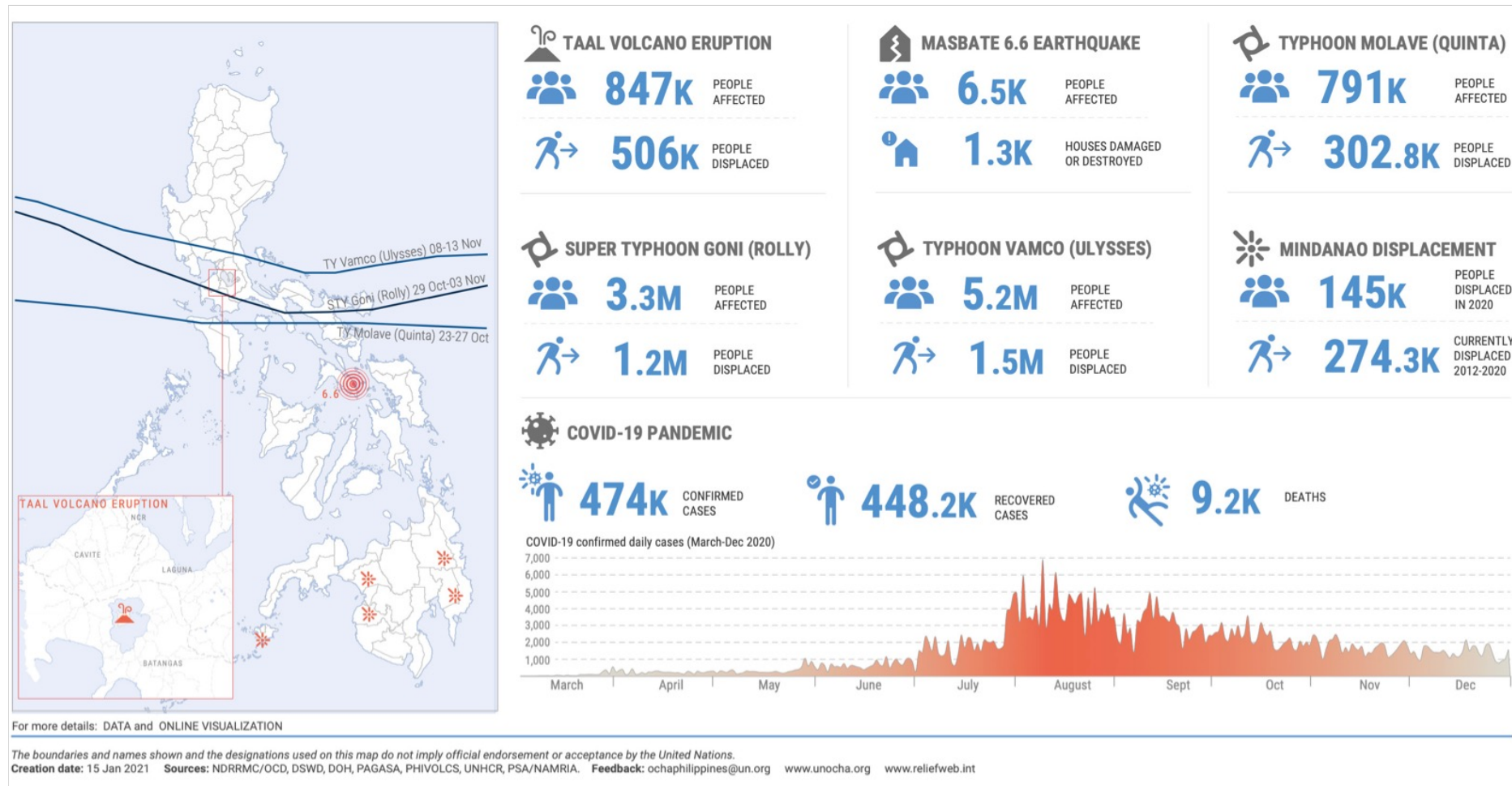

<https://reliefweb.int/report/philippines/philippines-2020-significant-events-snapshot-14-january-2021>



<https://www.bbc.com/news/world-asia-27601951>



<https://news.un.org/en/story/2014/02/461962>



<https://www.todayonline.com/world/philippine-refugee-tent-fire-kills-mother-5-kids>





<https://www.rappler.com/moveph/44364-emergency-shelter-kits-yolanda-survivors/>

Less flexible



Soft soil. Weak after heavy rain



Not suitable for life in the Philippines



# Concept

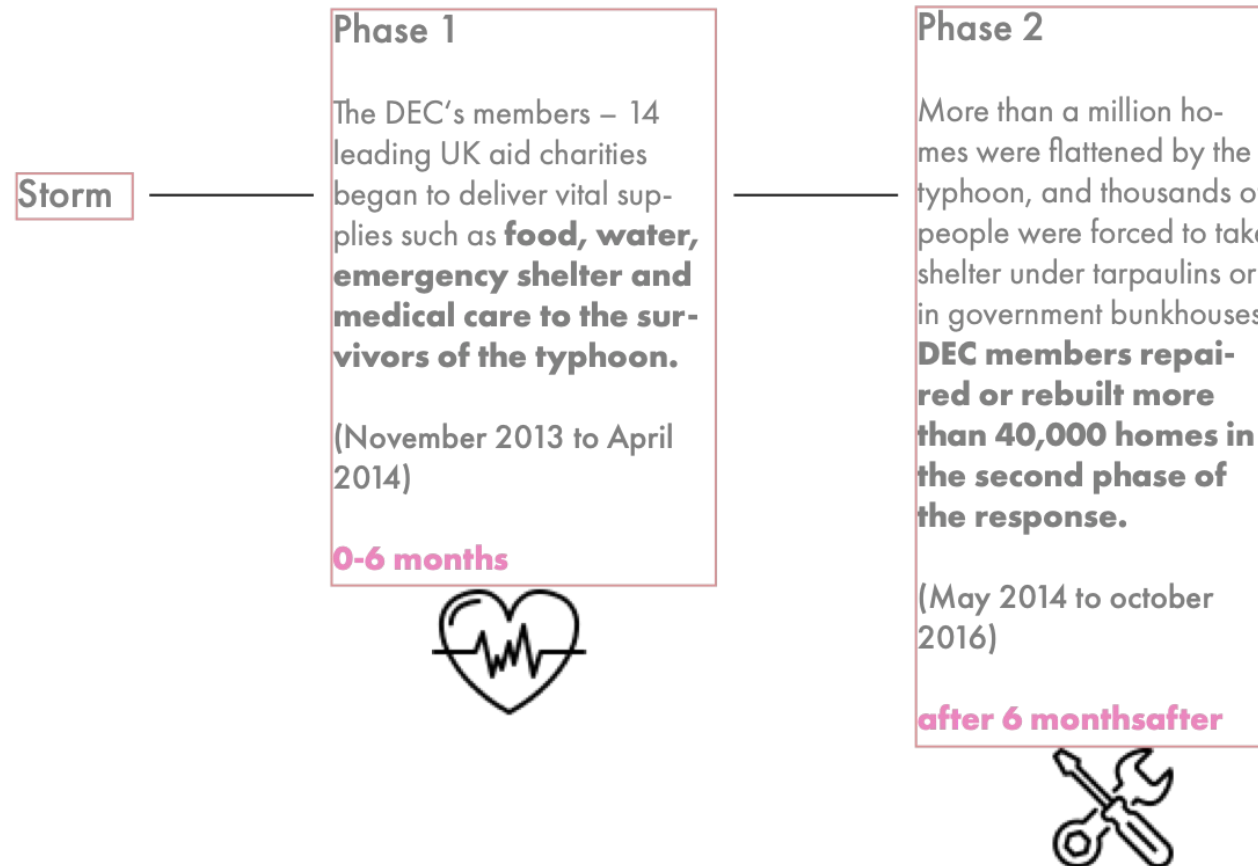

<https://www.dec.org.uk/article/philippines-typhoon-facts-and-figures>

# What happens after a typhoon.

## Phase 1

After 2-3 days

we make prefabricated shelters for essential needs on the hill

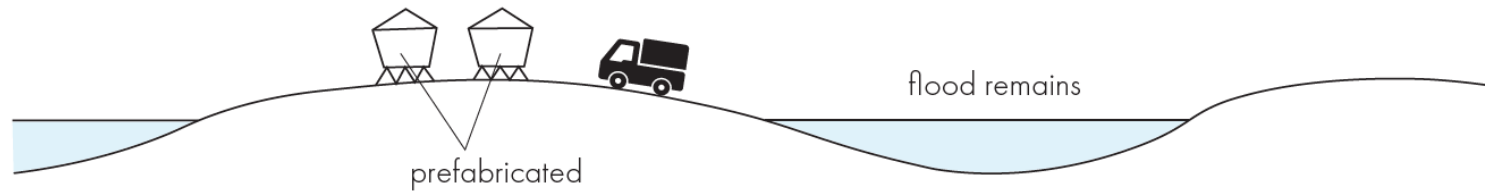

After 10 -15 days

People make their own house by their hands and increase the number of shelters.

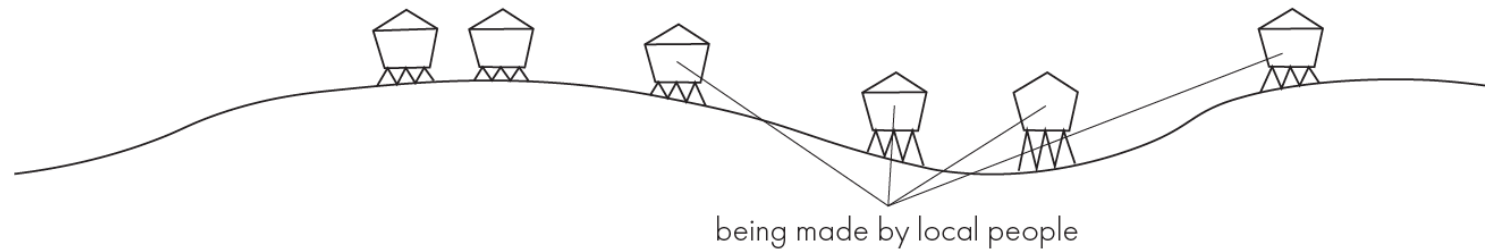

After 30 days if it is raining

Both of prefabrocatod shelter and handmade shelter are resistant to light rain

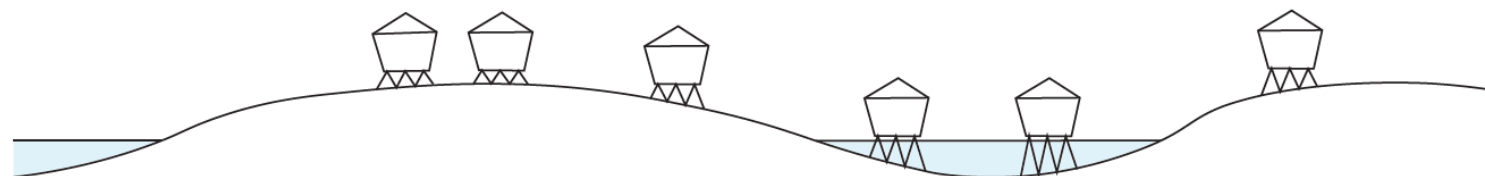

What happens after a typhoon.

## Phase 2

After 90 days

the season changed local people rebuild their house

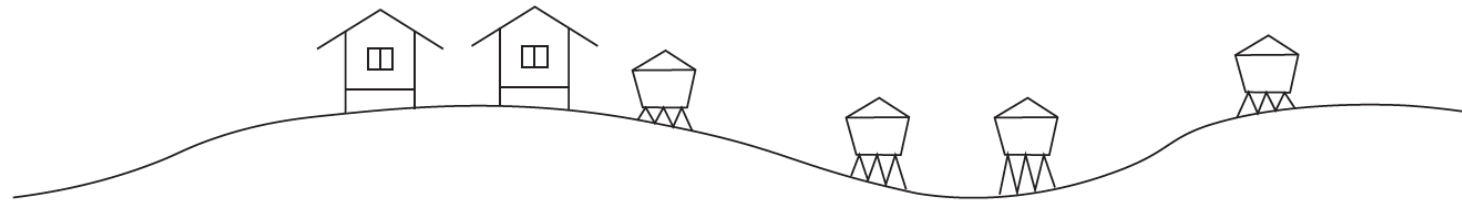

After 100 days

As the transformation concept, we can use the shelter as different function.

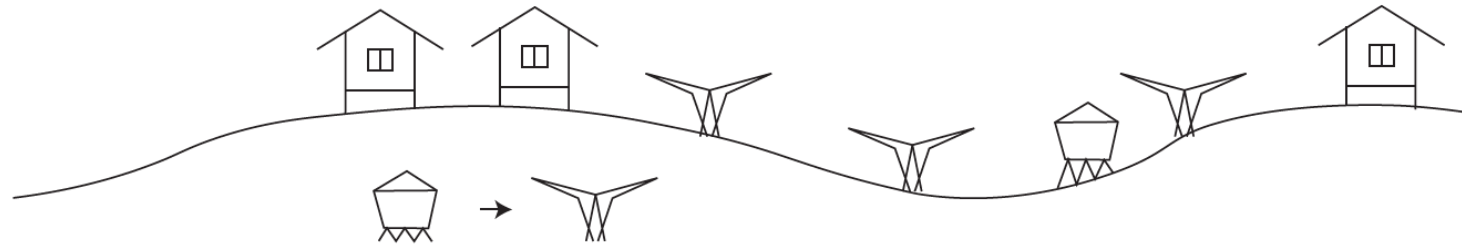

After 1 year

We can prepare for the next typhoon disaster.

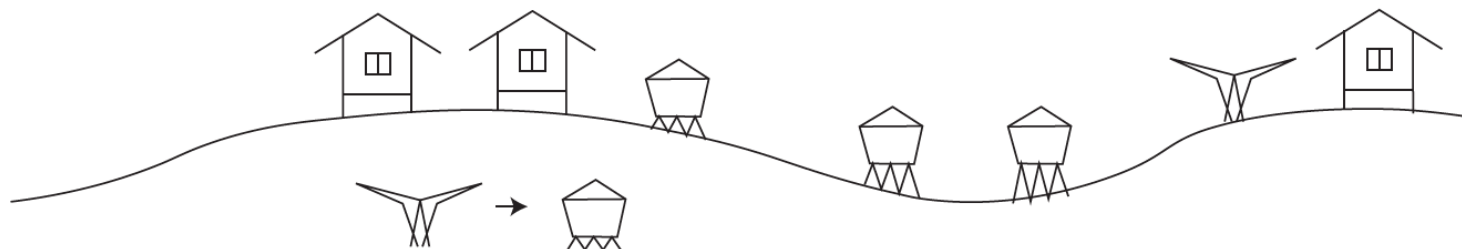

# Proposal aim

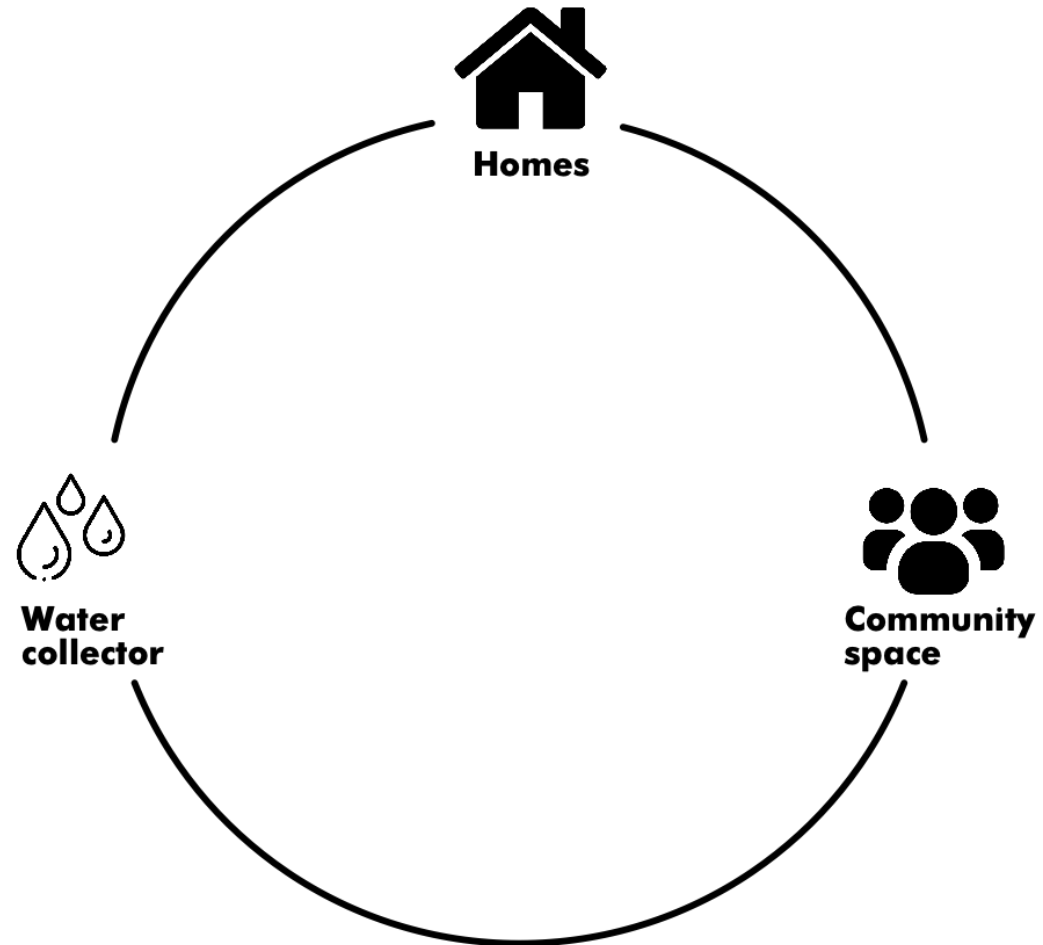

# Proposal aim



**Simple  
construction**



**durable**



**lightweight**

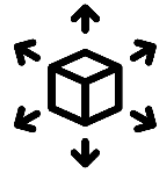

**deployable**

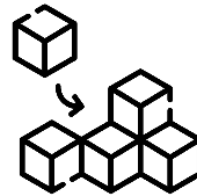

**modular**



**local material**

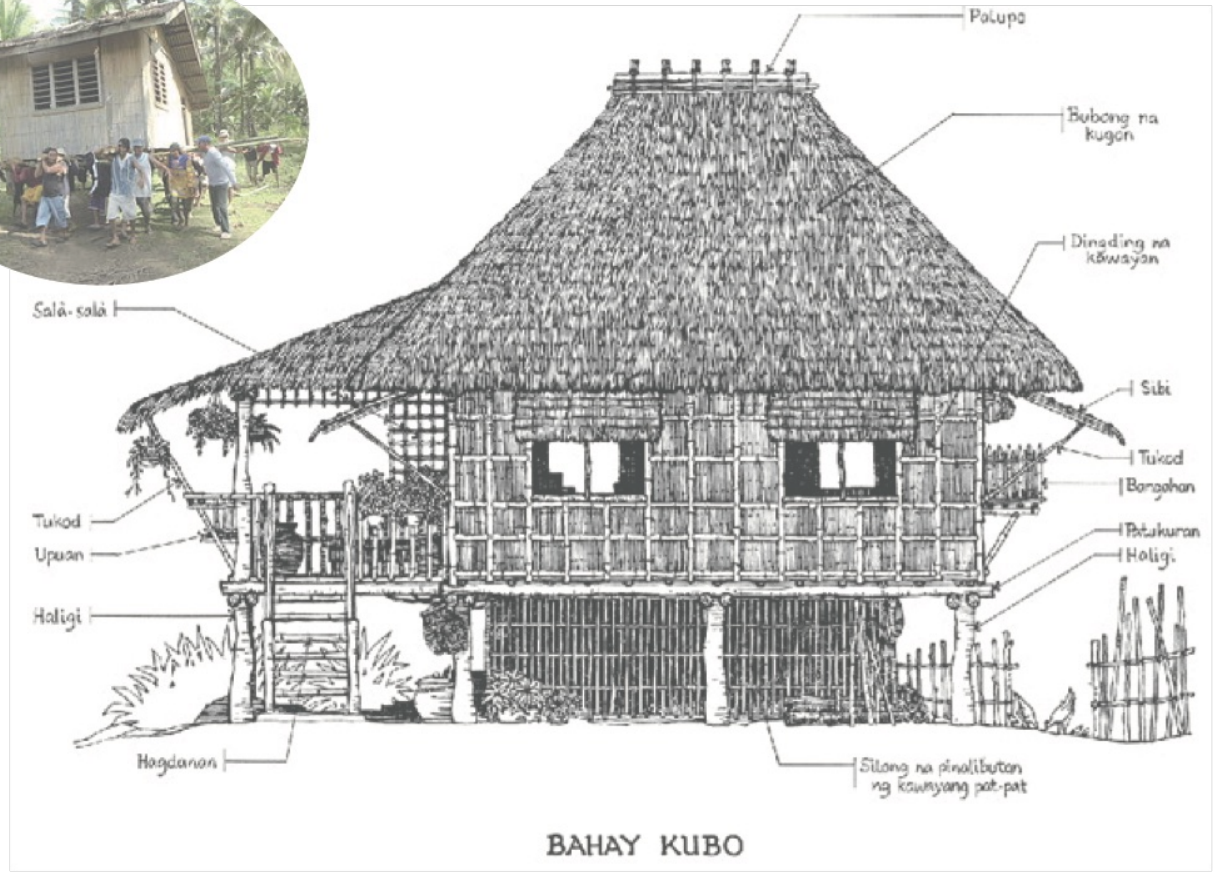

[https://en.wikipedia.org/wiki/Bahay\\_kubo](https://en.wikipedia.org/wiki/Bahay_kubo)

<https://www.realliving.com.ph/lifestyle/arts-culture/5-ways-to-achieve-filipino-style-a00043-20170224>



# Bahay Kubo reference



**steep roof**



**elevated  
foundation**

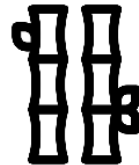

**local material**



**way of living**

# Variations

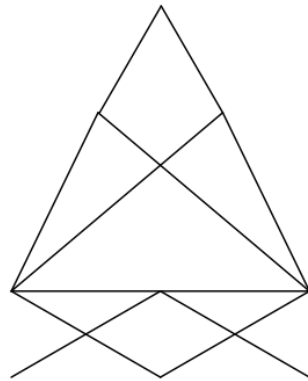

**Prefabricated shelter**

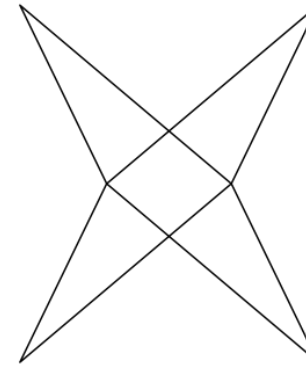

**Water collector**

# Phase 1

# Shelter structure



delivery shape

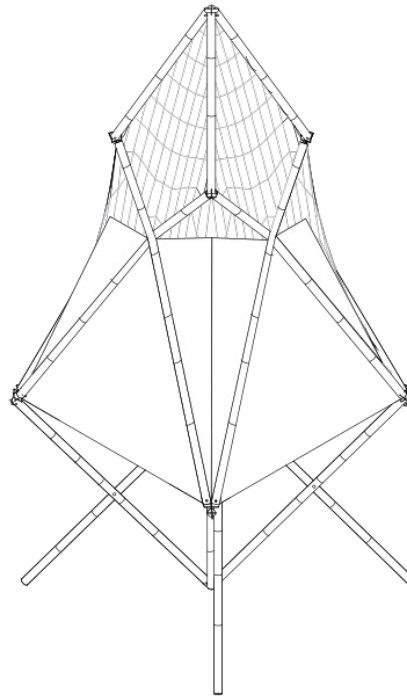

rainy shape

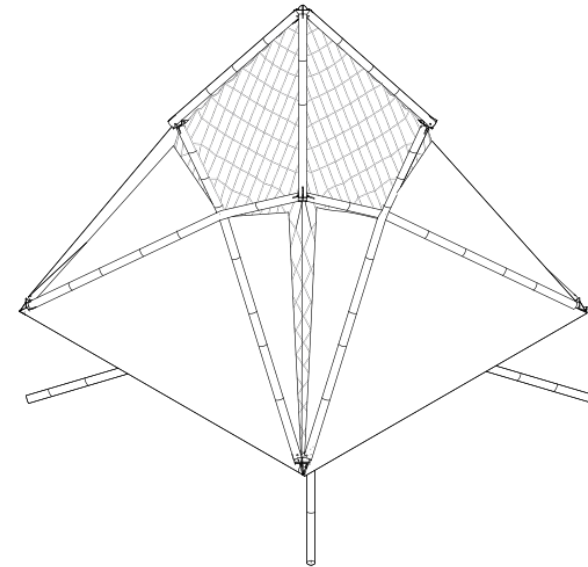

sunny shape

# Assembly process

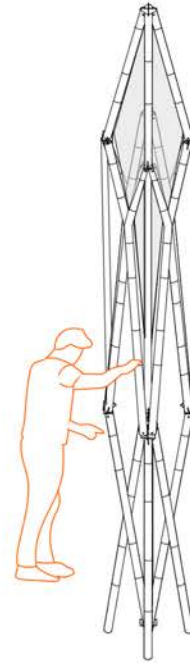

# Floorplan modularity



scale 1/100



scale 1/100

# Perspective section

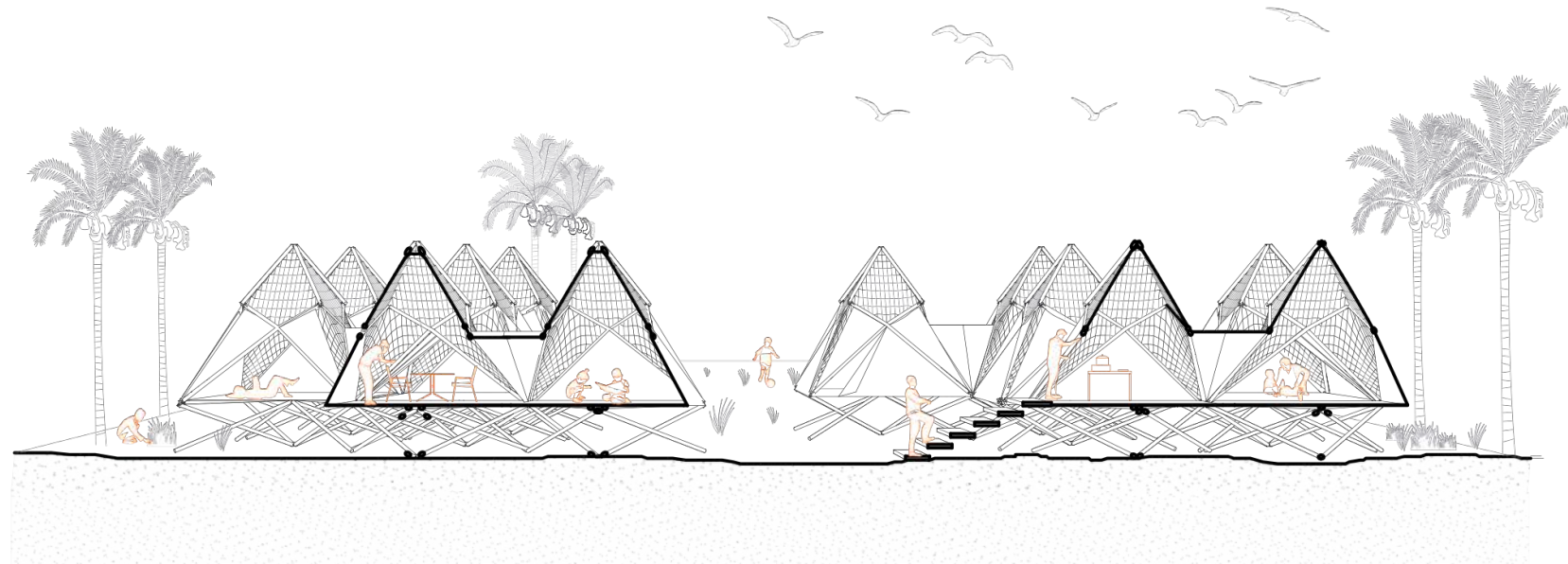



# Adaptivity and transformation



Elevation 1/100

# Adaptivity and transformation

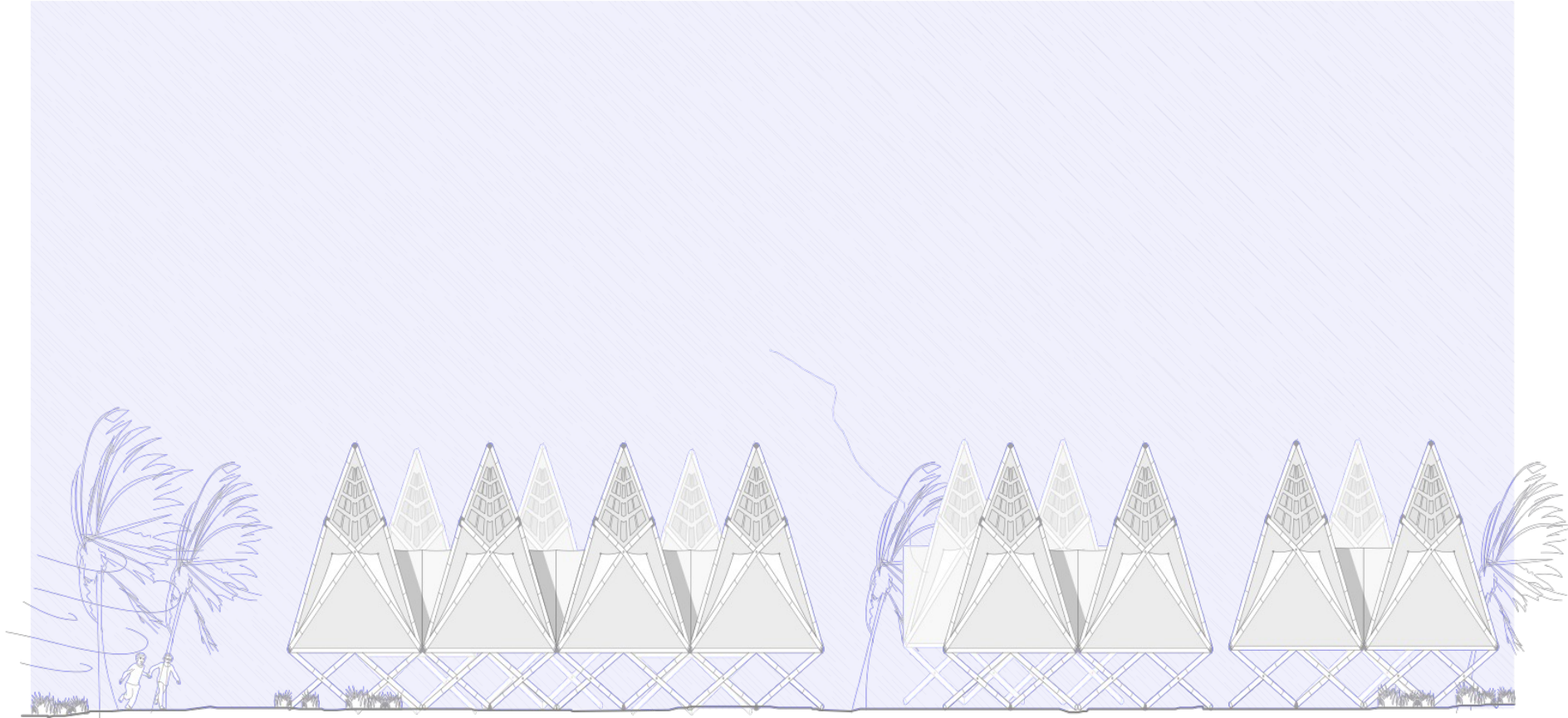

Elevation 1/100

# Explosion

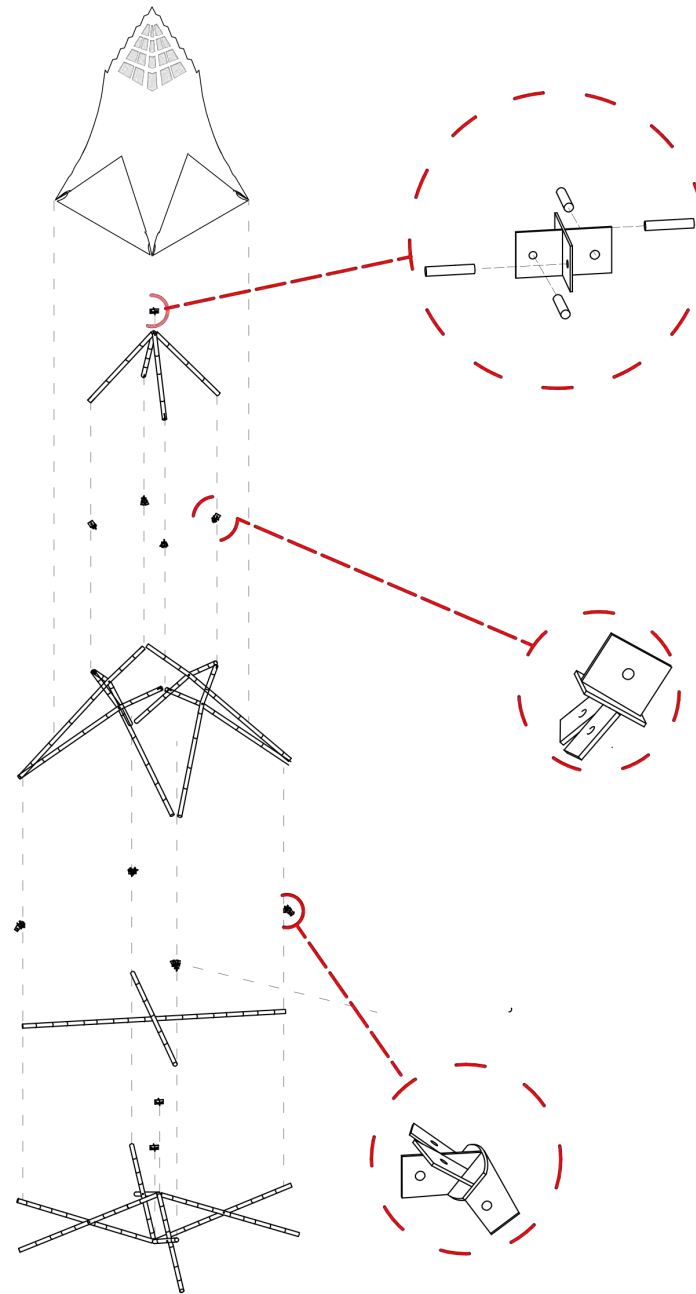

# Roof joint detail 1/5

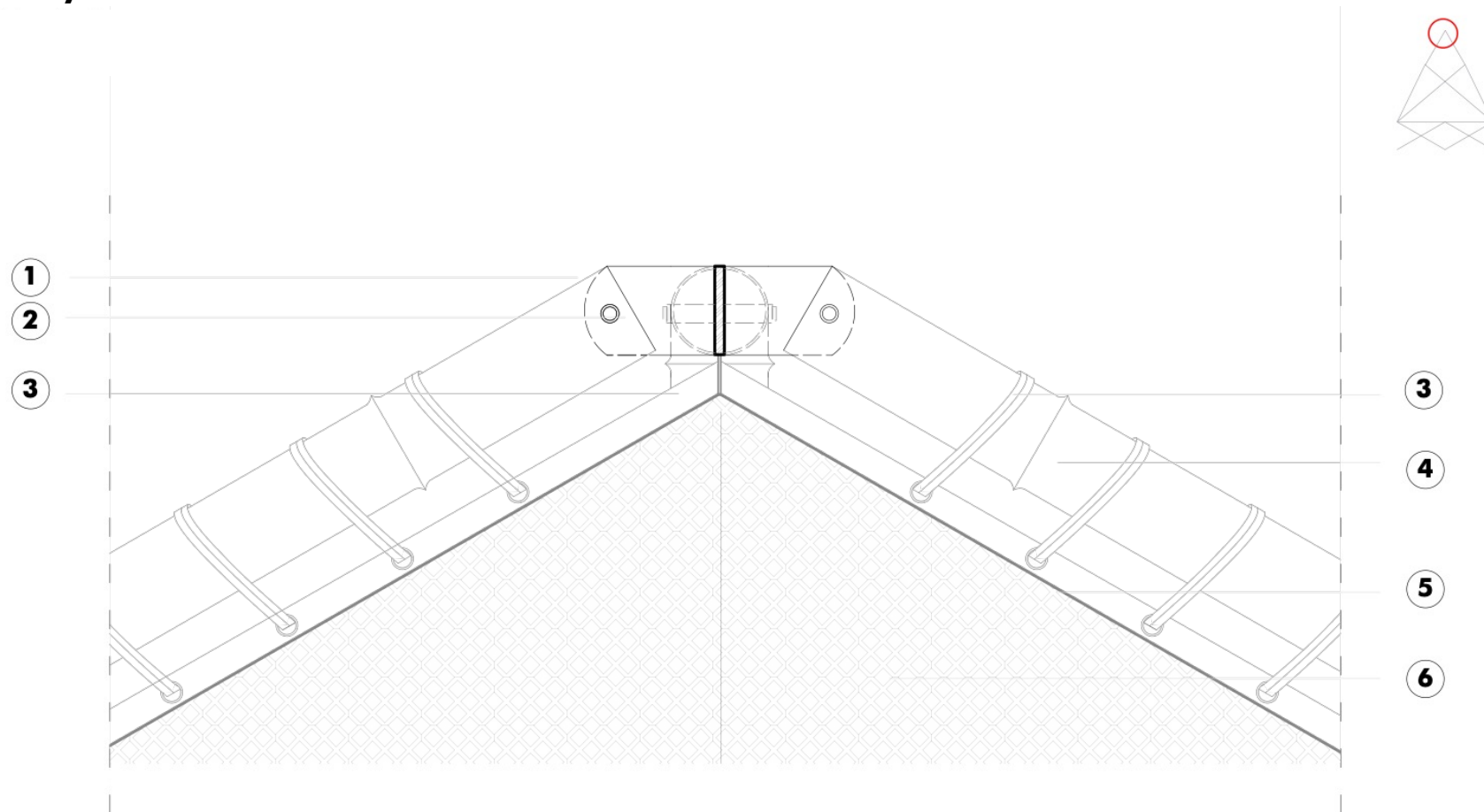

1. Roof joint
2. Bolt 1.5 cm
3. Bamboo Bar 8cm
4. Bamboo string
5. Envelope flap
6. Envelope recycled PET

# Connection joint detail 1/5

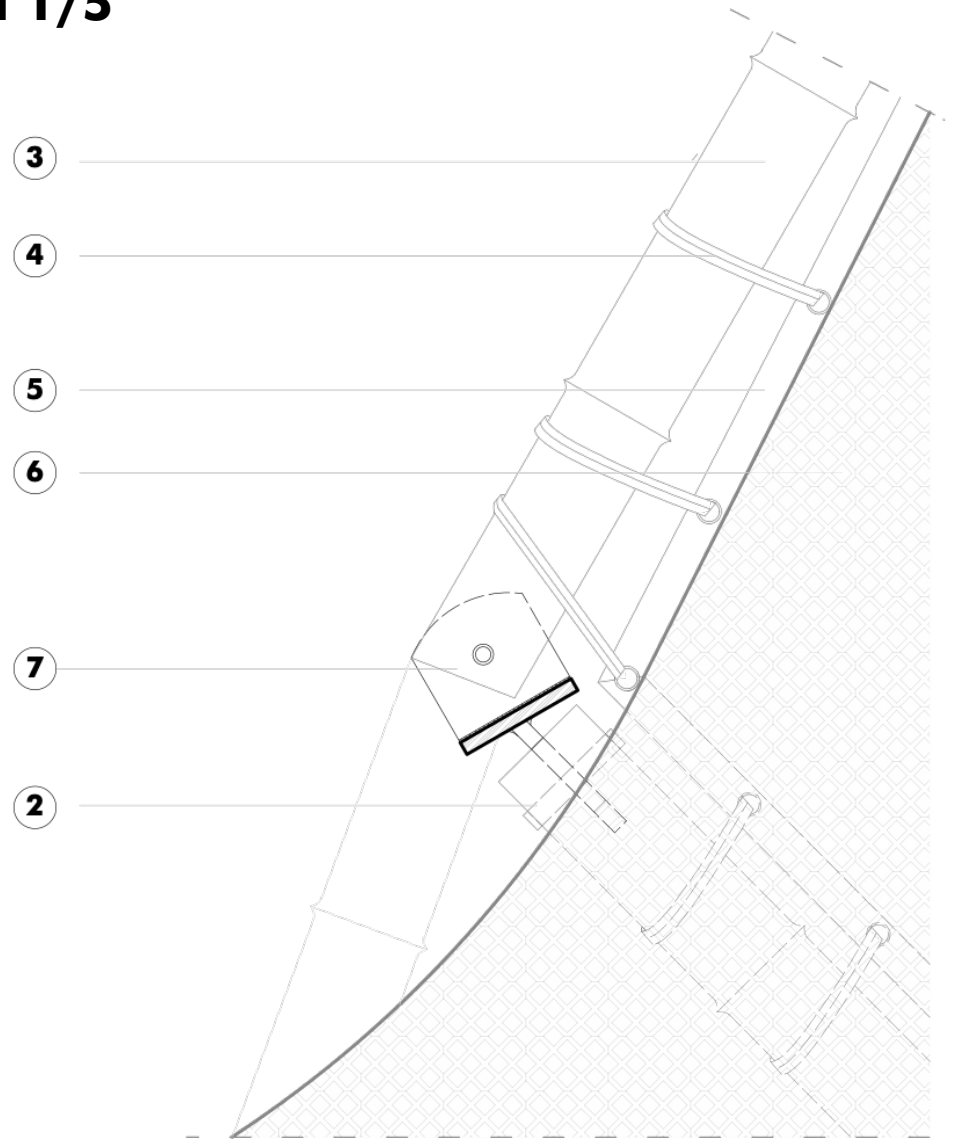

- 2. Bolt 1.5 cm
- 3. Bamboo Bar 8cm
- 4. Bamboo string
- 5. Envelope flap
- 6. Envelope recycled PET
- 7. Connection joint

# Floor joint detail 1/5

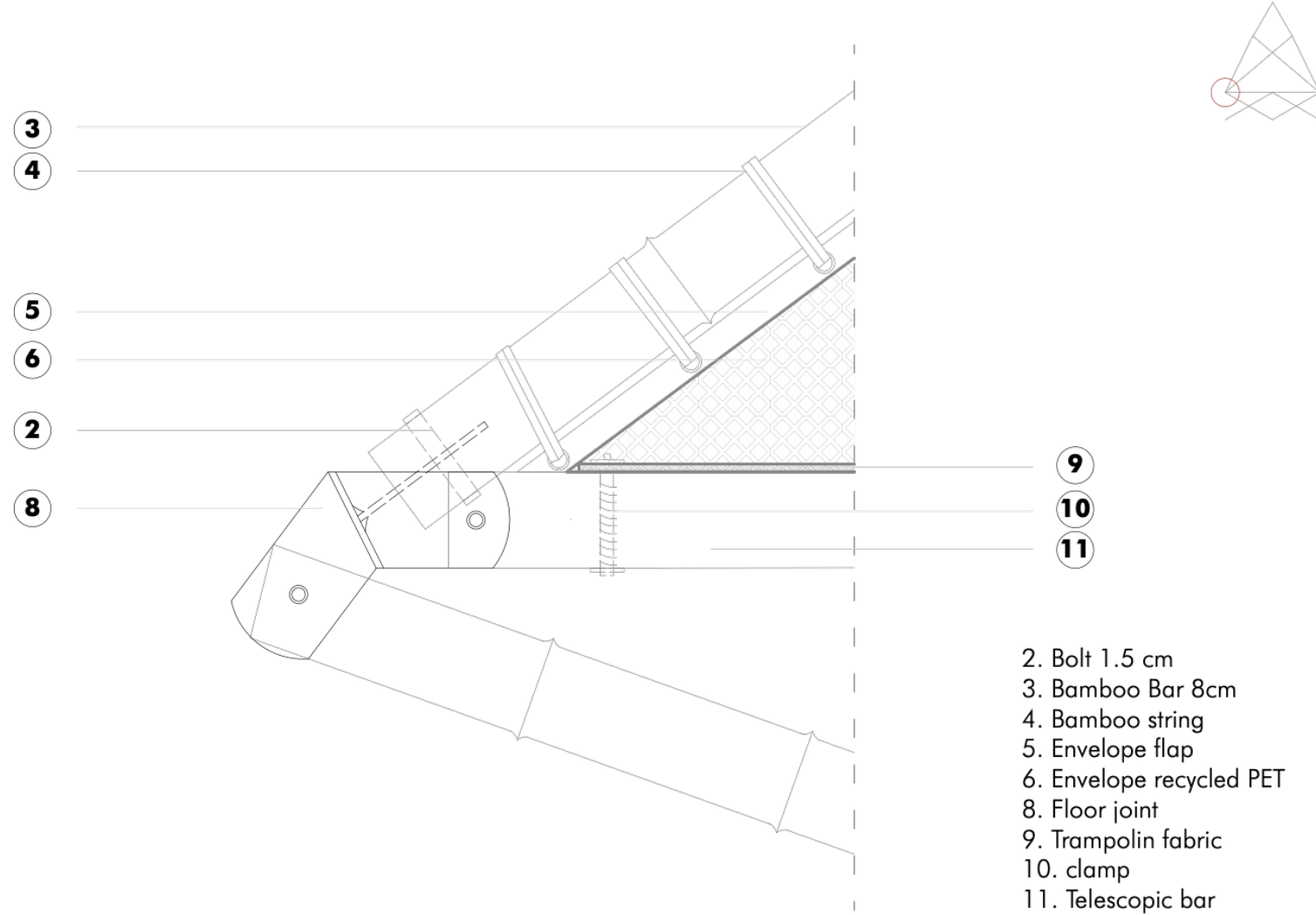

# Disassembly process

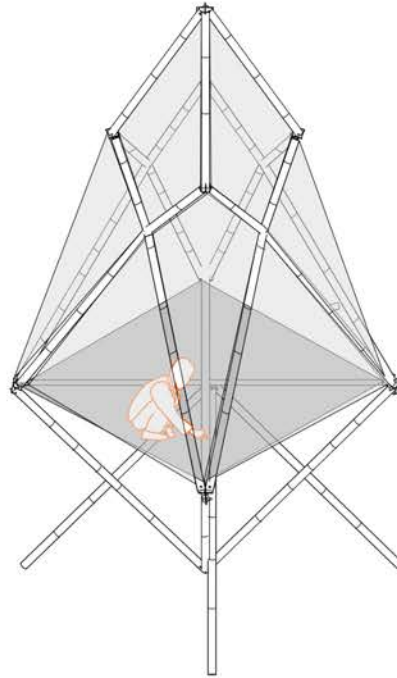

# Solar energy concept

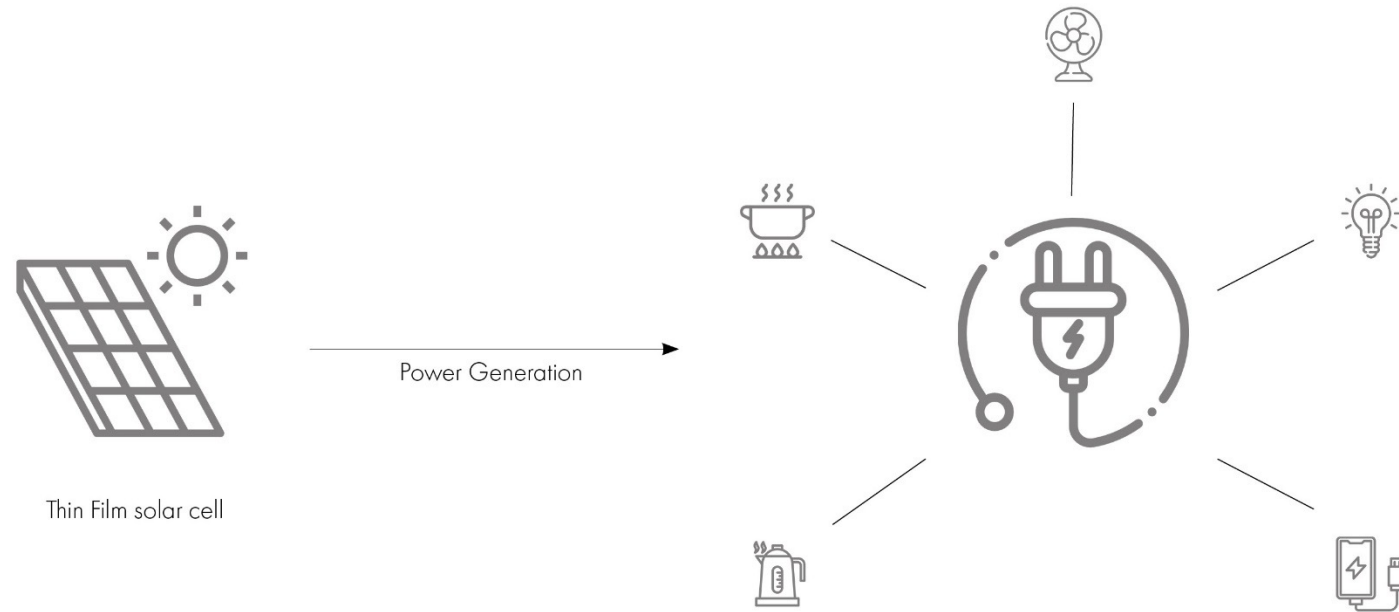



# Solar energy concept

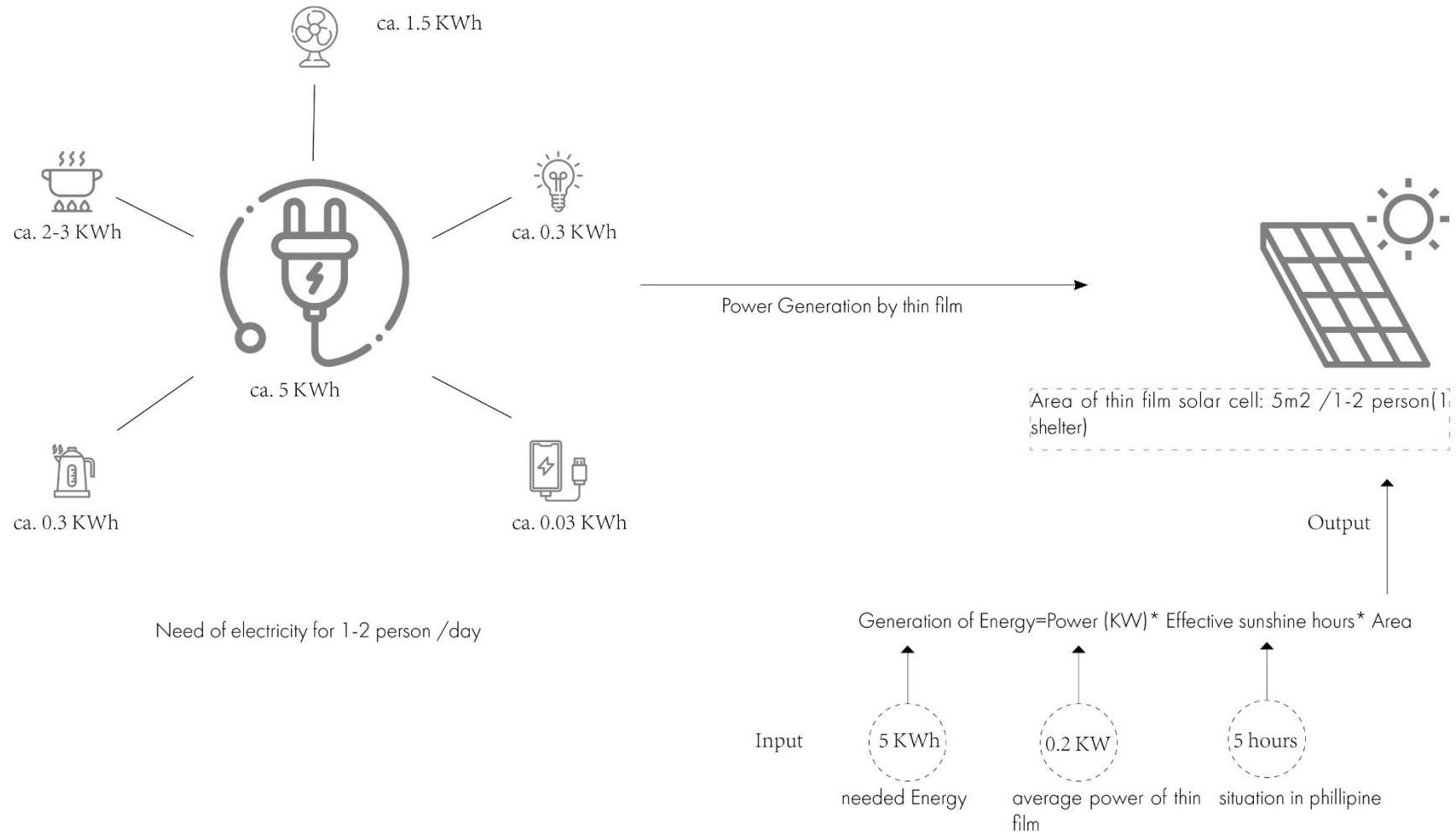

# Solar energy concept reference



<https://materialdistrict.com/article/tensile-solar-panel/>

<https://www.core77.com/posts/19379/smit-tensile-solar-lightweight-modular-solar-power-19379>

# Solar energy concept

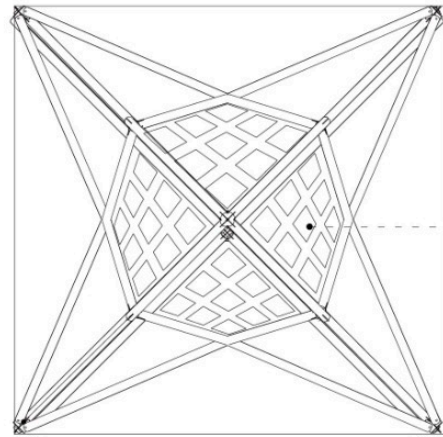

Thin film solar cell

Top view

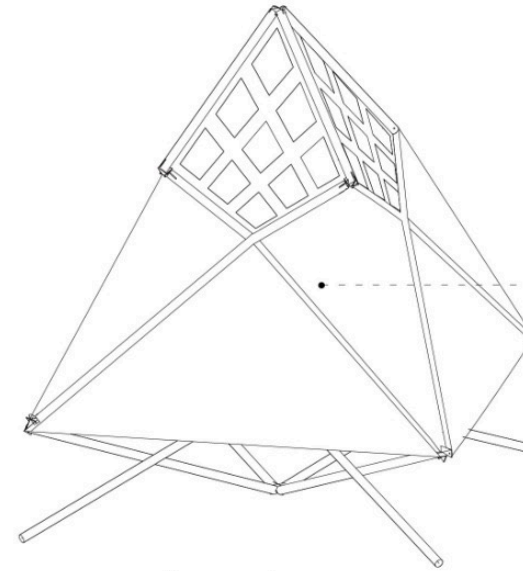

PET fabric

Axonometry

## Phase 2

# Transformation | Water collector

One modul

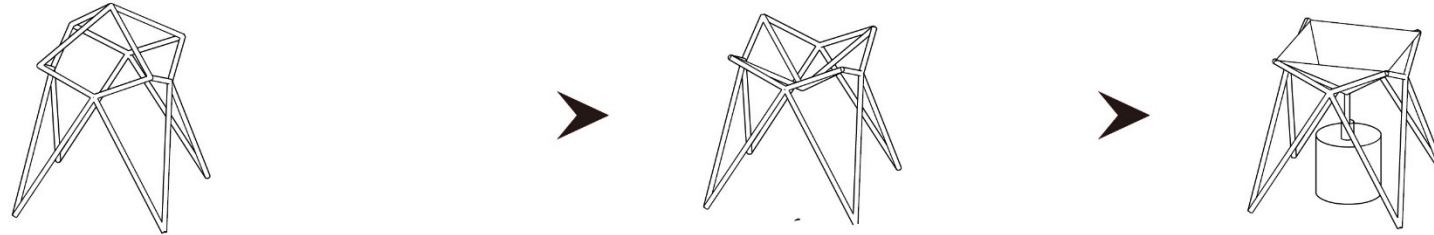

Two modul

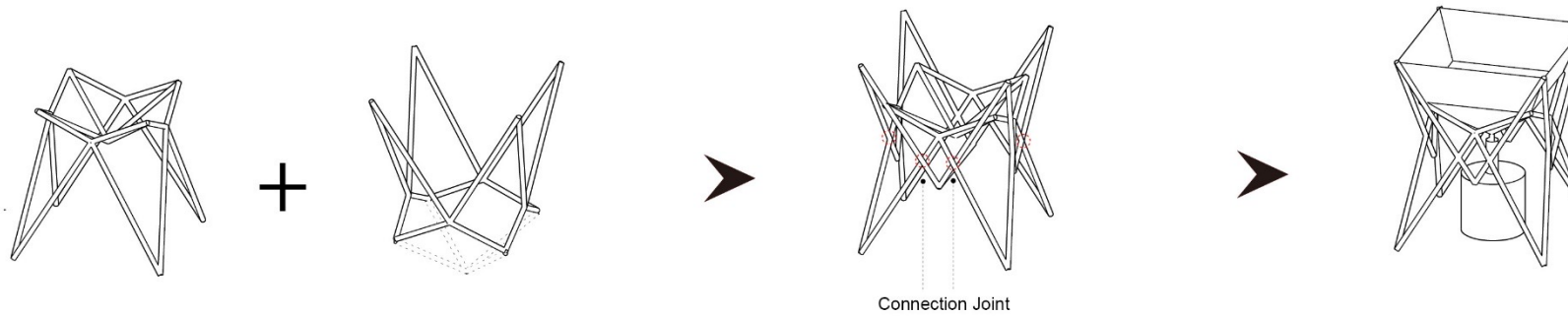

# Transformation | Water collector

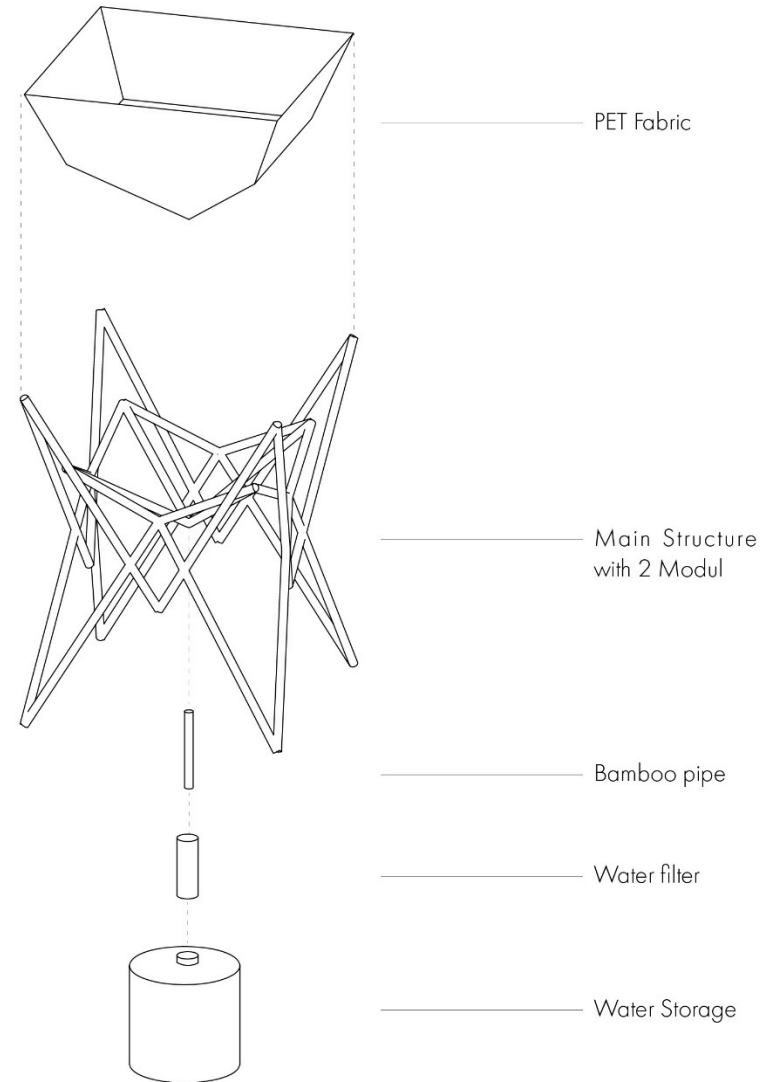
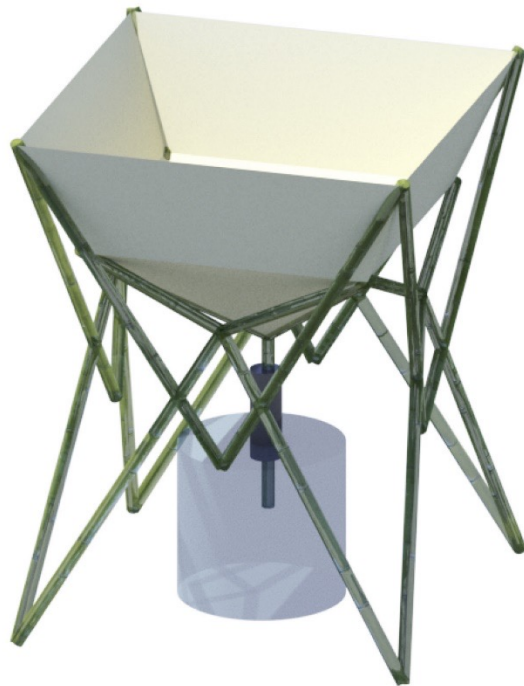

# Rendering

# Exterior





